

MODELLEN VOLGENS TEKENING

Voor modelruiten volgens tekening dienen de maten aangehouden te worden zoals aangegeven bij de betreffende modelruit. Tekeningen met een onvolledige maatvoering worden niet in behandeling genomen.

Bij verstrekte tekeningen wordt uitgegaan van de volgende basisgegevens:

- het aanzicht is het buitenaanzicht.
- de buitenruit is (voorzover van toepassing):
 - de dikste floatglasruit;
 - de reflecterende glassoort;
 - de in de massa gekleurde ruit.
- de binnenruit is (voorzover van toepassing):
 - de dunste floatglasruit;
 - het gelaagde glas;
 - de figuurglasruit;
 - de Low-E (HR) ruit.

Belangrijk:

- Voor de oppervlakteberekening dient men de kleinste rechthoek te nemen waarin de modelruit past.
- Voor bepaling van de modeltoeslag verwijzen wij naar het betreffende hoofdstuk waar de basisprijzen en modeltoeslagen van het betreffende glas staan vermeld.

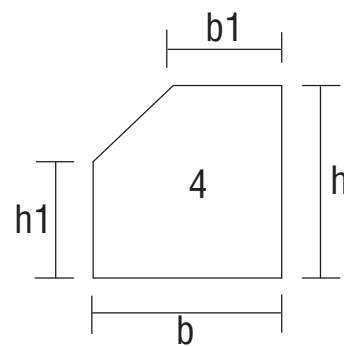
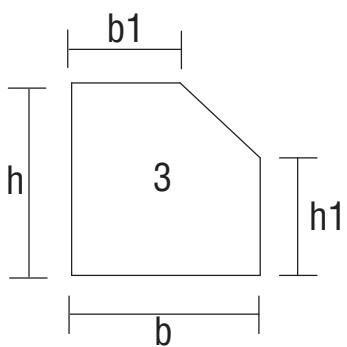
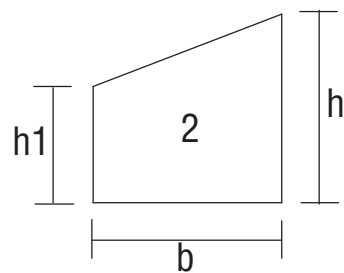
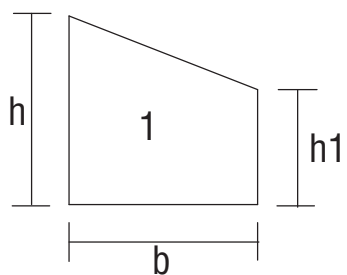

Modelnummer 5 is vervallen

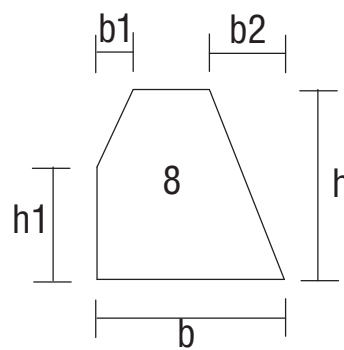
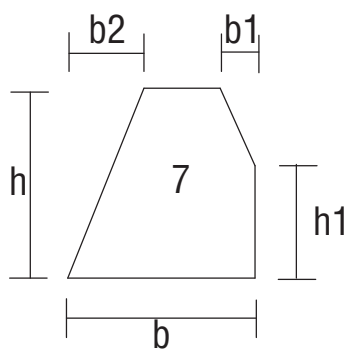
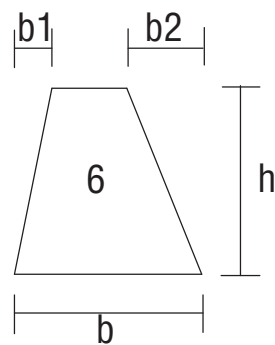

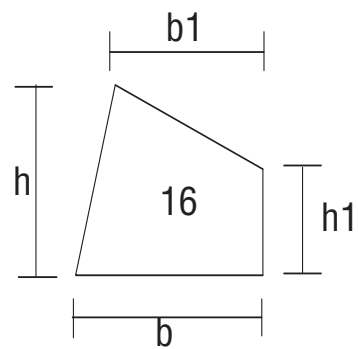
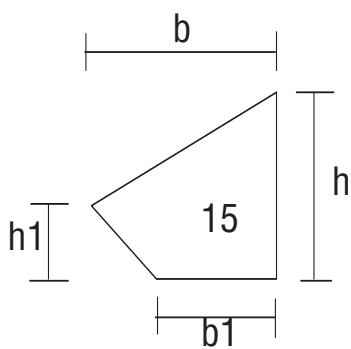
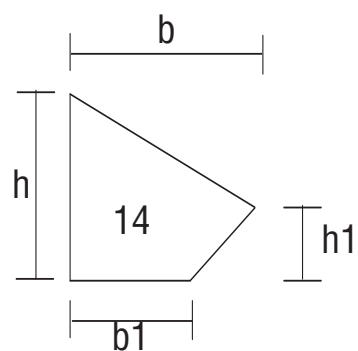
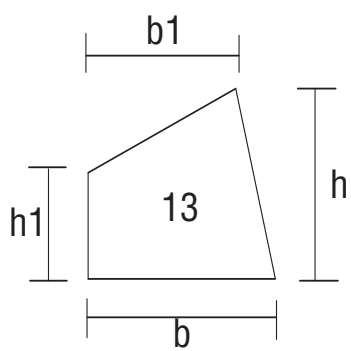
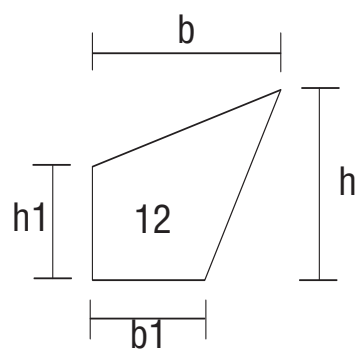
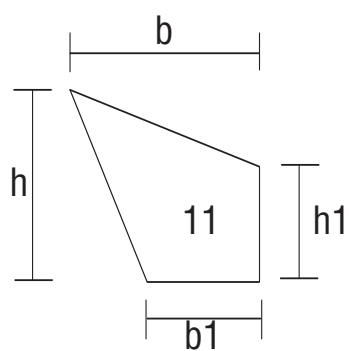
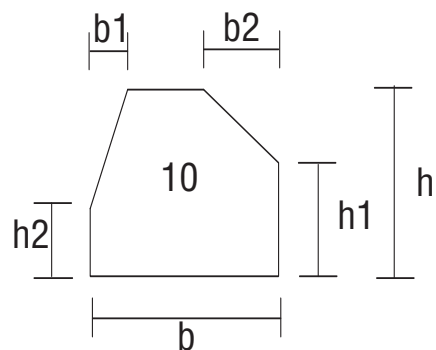
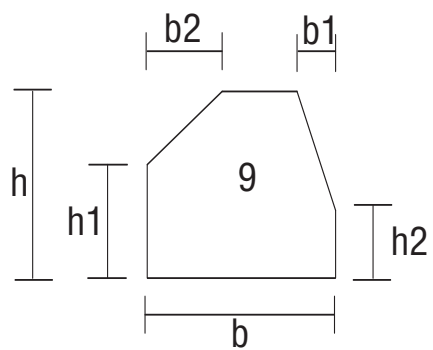

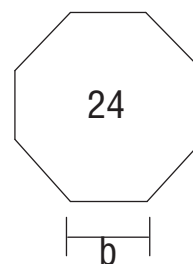
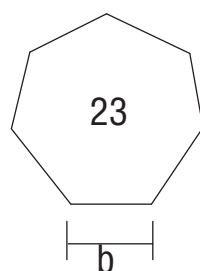
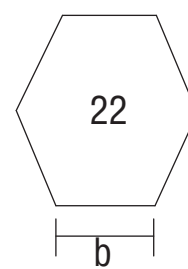
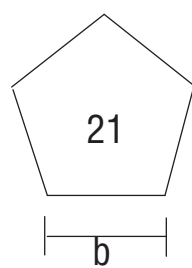
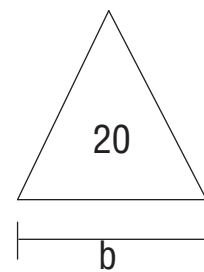
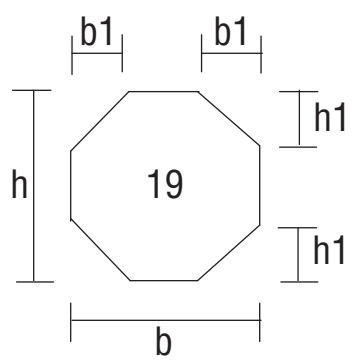
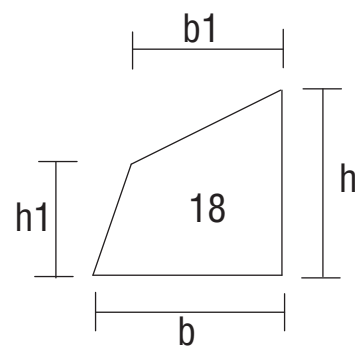
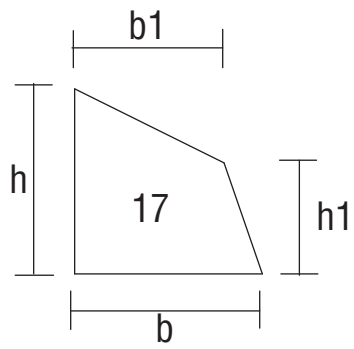

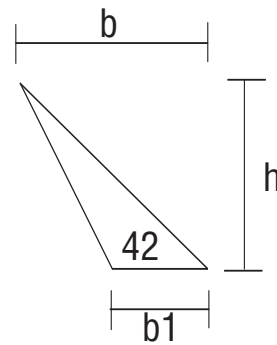
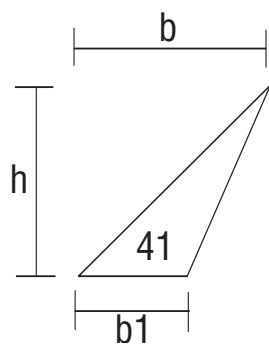
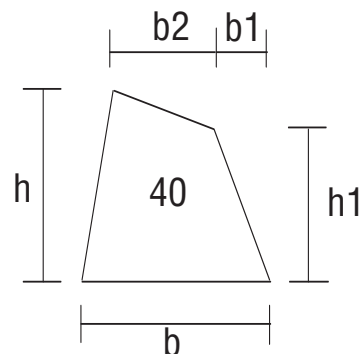
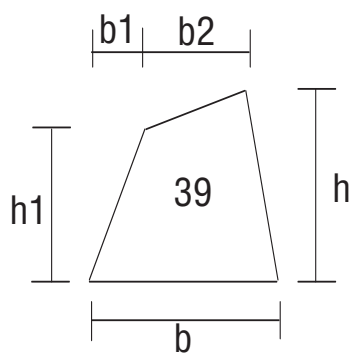
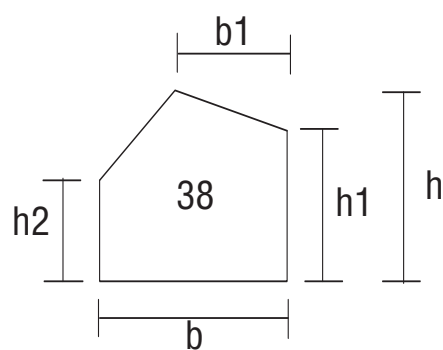
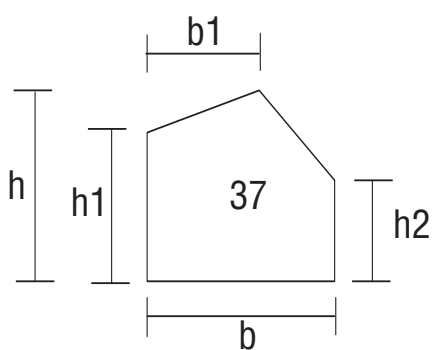
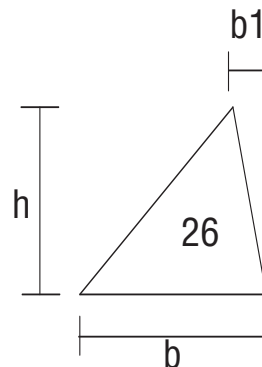
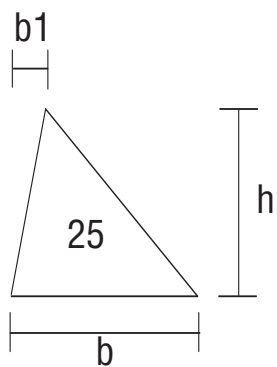

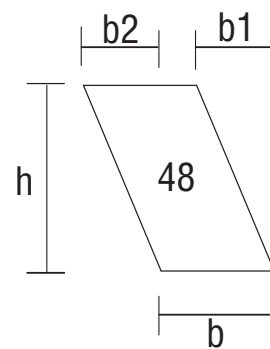
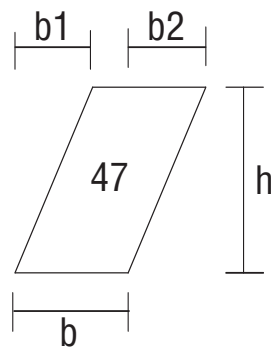
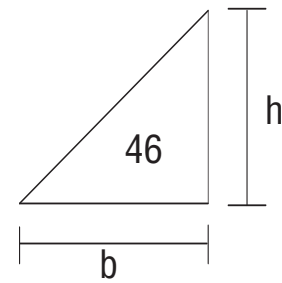
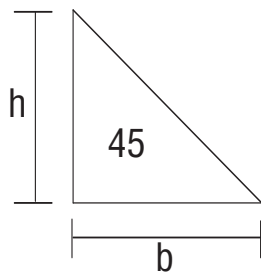
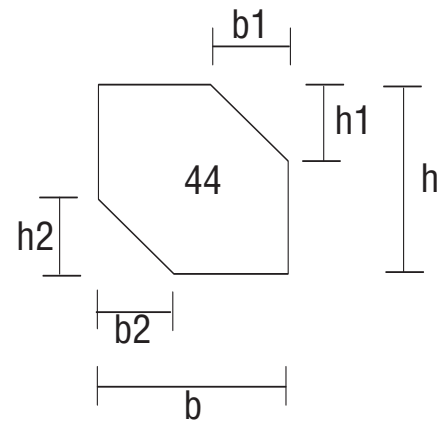
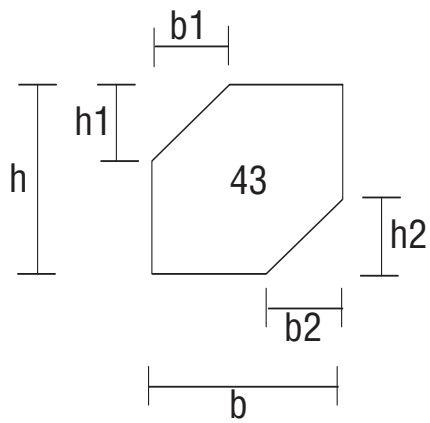

Modelnummer 51 is vervallen

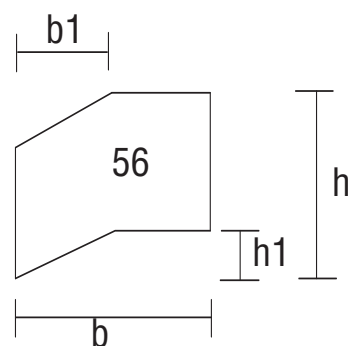
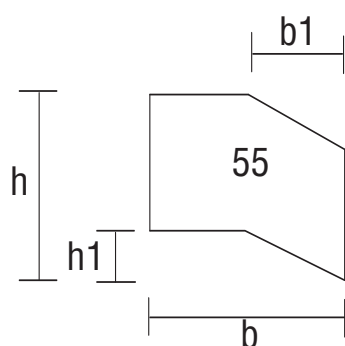
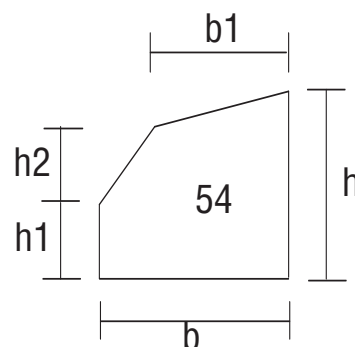
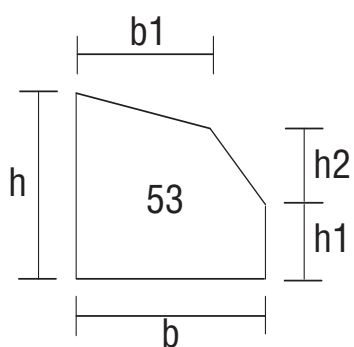

*Modelnummers 55 en 56 alleen uitvoerbaar in SGG SECURIT

Modelnummers 57 en 58 zijn vervallen

